

Long-Term Storage of Aluminum Electrolytic Capacitors

What are Aluminum Electrolytic Capacitors?

- Aluminum Electrolytic Capacitors (also known as Al Caps) are one of the oldest capacitor technologies in use by the electronics industry

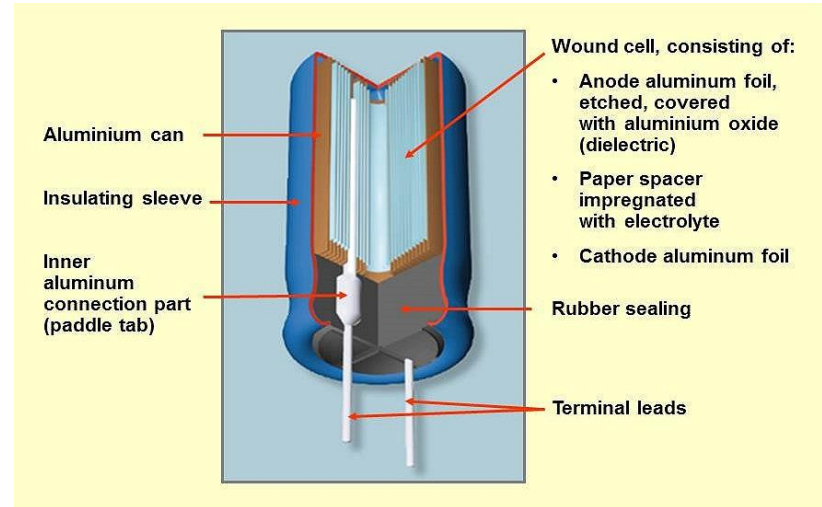

- Al Caps consists of two aluminum foils, one cathode and one anode, with a paper spacer infused with liquid electrolyte
 - The two foils and the spacer are stacked like a sandwich and then tightly wound into a roll
 - The roll is placed inside an aluminum can and then sealed with a rubber (EPDM typically) or epoxy bung

What are Aluminum Electrolytic Capacitors? (cont.)

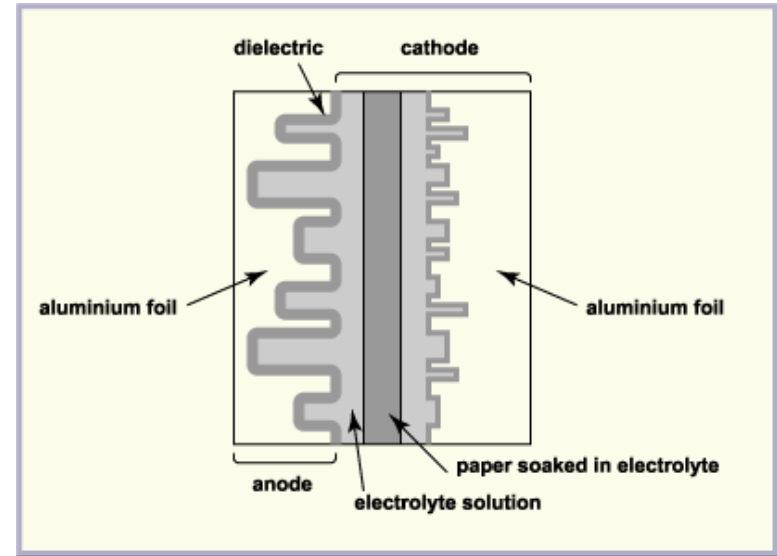
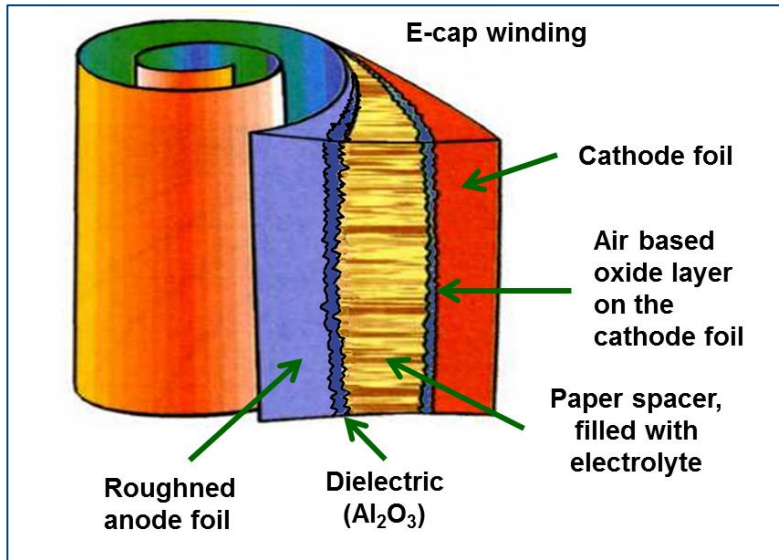

- The capacitance comes from a thin layer of aluminum oxide formed on the anode foil that has been etched/roughened
 - The greater the degree of etching/roughness, the larger the surface area of the aluminum oxide (Al_2O_3), the higher the capacitance
- The cathode foil also has an aluminum oxide layer, but it is relatively insignificant and is designed to not effect the conductivity between the cathode foil and the electrolyte solution

Aluminum Oxide Formation

- The cathode film tends to be formed in moist air
 - Creates a porous oxide, very low electrical resistance, with a crystalline structure
- The anode film is formed through immersion in an electrolyte solution
 - For low voltage (less than 100V) capacitors, electrolyte is typically a proprietary combination of water, ethylene glycol, weak organic acids, and other additives

WARNING: Tradeoff Alert!

- Capacitance is a function of dielectric constant (ϵ), dielectric area (A), and thickness (t)
 - $C = \epsilon \times A / t$ (for Al-Caps, specifically $C = 8.8e-8 \times A \text{ (in cm}^2\text{)} / t \text{ (in cm)}$)
- Al_2O_3 has a limited dielectric constant (see below)...
 - Polyethylene, Polypropylene, Polystyrene (Film Capacitors): 2 – 3
 - Aluminum Oxide (Aluminum Capacitors): 7 – 10
 - Tantalum Dioxide (Tantalum Capacitors): ~100
 - Barium Titanate (Ceramic Capacitors): 1,000 – 10,000
- ...but the etching and forming process can create a very thin (10 to 100 nm) coating with a large surface area (thousands of square centimeters)
 - Tradeoff Alert: The thinner the dielectric and the greater the degree of etching, the lower the voltage breakdown strength of the capacitor

Why Al-Caps?

- Selection of liquid Al-Caps vs other capacitor types (ceramic, tantalum, polymer, film) tends to be driven by a combination of cost, voltage, capacitance, and ESR
- Liquid Al-Caps have some of the highest capacitance of any capacitor technology
- They can provide that capacitance at relatively low cost and at relatively high voltage
- Capacitance is also relatively stable over a range of voltages and temperature
- Equivalent series resistance (ESR) tends to be higher, but the impedance is stable as a function of frequency

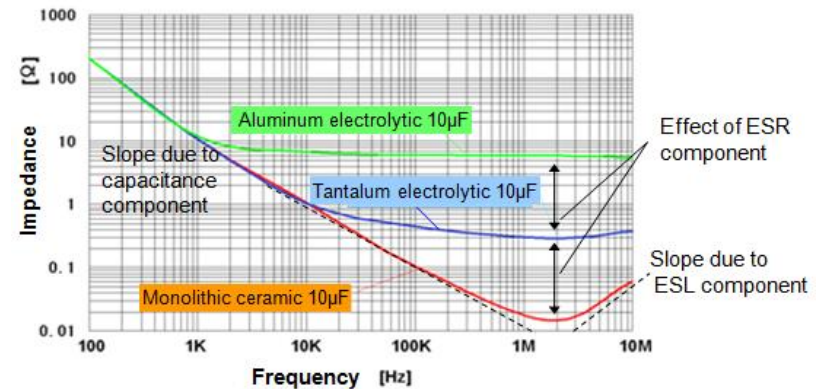
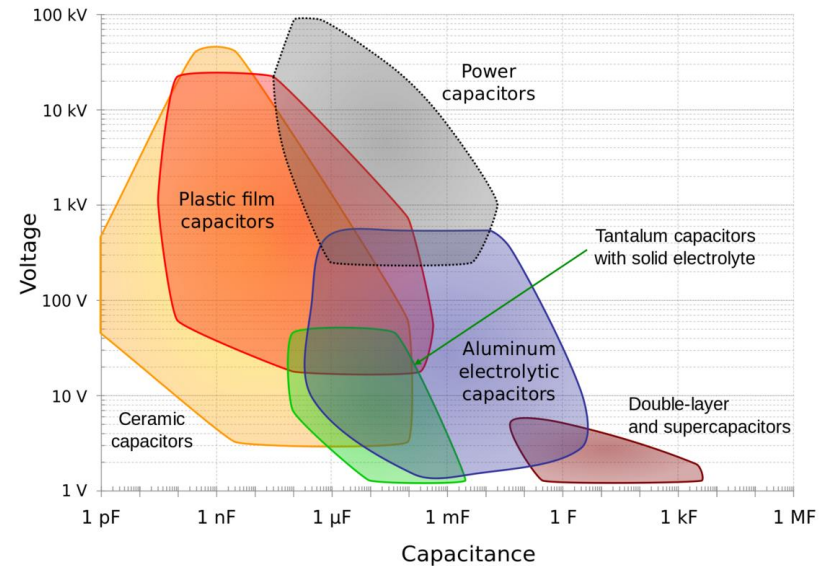
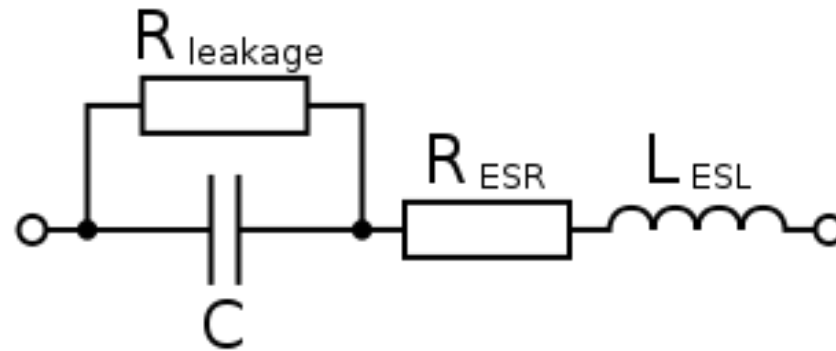

Fig. 4 Impedance characteristics

ESR vs. Impedance



$$X_C = -\frac{1}{\omega C}$$

$$X_L = \omega L_{\text{ESL}}$$

$$Z = \sqrt{ESR^2 + (X_C + (-X_L))^2}$$

How do Al-Caps Fail?

- **Most critical component in regards to limited lifetime**
 - Failure mode is typically evaporation of liquid electrolyte through the rubber seal/stopper
- **Evaporation prediction has been based on standard relationship**
 - Doubling of lifetime with every 10C drop in temperature (note: This is not Arrhenius!)

$$L_x = L_o \times 2^{(T_o - T_x) / 10}$$

- However, there are variations from manufacturer to manufacturer in regards to this equation

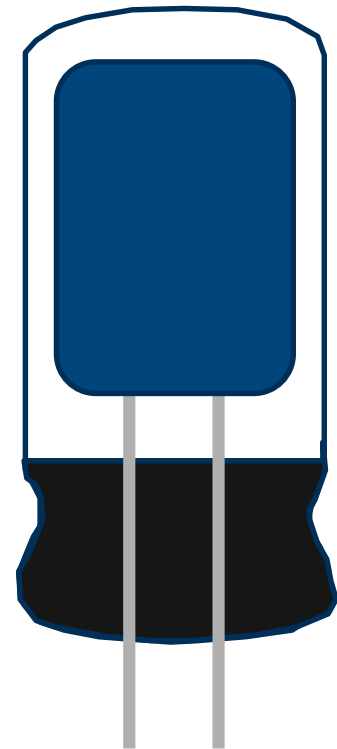

Capacitor Lifetime Calculations (Nichicon)

- L_r is rated lifetime
- T_r is rated temperature
- T is ambient temperature
- I_r is rated ripple current
- I is actual ripple current
- Δt_r is the temperature rise due to rated ripple current
- Δt is the temperature rise due to actual ripple current
- α and K are coefficients

$$L = L_r \times 2^{\frac{T_r - T}{10}} \times \frac{1}{B_n} \quad \text{Miniature w/o ripple}$$

$$B_n = 2^{\alpha} \times \left(\frac{I_r}{I}\right)^2 \times 2^{-\left(\frac{T_r - T}{30}\right)}$$

$$L = L_r \times 2^{\frac{T_r - T}{10}} \times 2^{\alpha} \times 1 - \left(\frac{I_r}{I}\right)^2 \times 2^{-\left(\frac{T_r - T}{30}\right)} \quad \text{Miniature w/ ripple}$$

$$L = L_r \times 2^{\frac{T_r - T}{10}} \times 2^{1 - \frac{\Delta t_r \times \left(\frac{I_r}{I}\right)^2}{K}} \quad \text{Large can}$$

Capacitor Lifetime Calculations (Nippon Chemi-Con)

- L_r is rated lifetime
- T_r is rated temperature
- T is ambient temperature
- I_r is rated ripple current
- I is actual ripple current
- Δt_r is the temperature rise due to rated ripple current
- Δt is the temperature rise due to actual ripple current
- A and K_v are coefficients

$$L = L_r \times 2^{\frac{T_r - T}{10}} \times 2^{-\frac{\Delta t}{5}}$$

Miniature w/o ripple

$$L = L_r \times 2^{\frac{T_r - T}{10}} \times 2^{\frac{\Delta t_r - \Delta t}{5}}$$

Miniature w/ ripple

$$L = L_r \times 2^{\frac{(T_r + 5) - (T - 25)}{10}} \times 2^{\frac{25 - \Delta t}{A}} \times K_v$$

Large can

Capacitor Lifetime Calculations (Rubycon)

- L_r is rated lifetime
- T_r is rated temperature
- T is ambient temperature
- I_r is rated ripple current
- I is actual ripple current
- Δt_r is the temperature rise due to rated ripple current
- Δt is the temperature rise due to actual ripple current
- V_r is rated voltage
- V is actual voltage
- A and K_v are coefficients

$$L = L_r \times 2^{\frac{T_r - T}{10}} \times 2^{\frac{\Delta t_r}{(10 - 0.25\Delta t_r)} - \frac{\Delta t}{(10 - 0.25\Delta t)}}$$

Miniature

$$L = L_r \times 2^{\frac{T_r - T}{10}} \times 2^{\frac{\Delta t_r}{10} - \frac{\Delta t}{10}} \times \left(\frac{V_r}{V}\right)^{2.5}$$

Large can

Capacitor Lifetime Calculations (Panasonic/Sanyo)

- L_r is rated lifetime
- T_r is rated temperature
- T_a is core temperature
- I_r is rated ripple current
- I is actual ripple current
- Δt_r is the temperature rise due to rated ripple current
- Δt is the temperature rise due to actual ripple current
- V_r is rated voltage
- V is actual voltage
- A and K_v are coefficients

$$L = L_r \times 2^{\frac{T_r - T_a}{10}}$$

All

E-Cap Life Prediction

- Major problem: Like all limited life components, predictions are extrapolated from manufacturers' ratings
 - The basis of these ratings, lifetime and temperature, is not always clear
- Issues
 - Failure definition can vary
 - Lifetime can be with or without ripple current
 - Probability of failure after lifetime is never defined (test to zero failures)
 - Different approaches to extend lifetime
 - Large volume of electrolyte
 - Higher boiling point electrolyte / lower vapor pressure
 - Better seal
 - Ability to operate at lower electrolyte volumes
 - Degradation of seal due to temperature or temperature cycling is never addressed

E-Cap Life Prediction (cont.)

- A better approach would be to establish a physics-based equation derived from
 - Electrolyte boiling point
 - Volume of electrolyte
 - Critical volume
 - Evaporation rate
 - Embrittlement rate of rubber/plastic stopper
- Unfortunately, most capacitor manufacturers consider this information 'proprietary'

How do Aluminum Electrolytic Capacitors Fail in Storage?

- Because of their construction and the way they are manufactured, aluminum electrolytic capacitors are especially susceptible to degradation during storage (also known as shelf life)
- There are two degradation modes in regards to long-term storage of aluminum electrolytic capacitors assembled to printed circuit boards.
 - Electrolyte Evaporation
 - Dielectric Dissolution
- Note: Modern electrolyte formulations are extremely stable and should not experience any change in performance over reasonable storage times and temperature

Electrolytic Evaporation

- For low voltage capacitors (approximately less than 100V), the degradation rate of this mechanism is the same whether the capacitor is charged or not
 - The approximation of 2X lifetime for every 10C below manufacturer's rating is still valid
 - The different manufacturers formulas theoretically are all the same when voltage and ripple current go to zero
- It is very important to note that most capacitor manufacturers will not 'guarantee' lifetimes beyond 15 years due to concerns regarding degradation of the stopper/bung

Dielectric Dissolution

- The aluminum oxide dielectric is formed through the application of a voltage bias (also known as forming voltage)
- If there is no bias applied for long periods of time, the dielectric will slowly dissolve back into the solution due to dielectric polarization caused by impurities which exist in the aluminum from manufacturing
- In this case, the time for dissolution is much shorter than the rated lifetime
 - Typically no more than 1 000 hours at rated temperatures.

Prior Work

- There is very limited published data on storage lifetime of aluminum electrolytic capacitors
 - Greason and Critchley, 1986, IEEE CHMT
 - E. Wynne, 2002, Thesis
- Greason identified leakage current up to 136X higher than the starting leakage current after 3000 hrs at 85C at low voltage (1V applied on a 50V rated capacitor))
- Wynne evaluated radial and axial capacitors stored for 10 years in an uncontrolled warehouse (40 to 140F)
 - Measured leakage current, ESR, and capacitance of 28 samples from each capacitor type
 - All 56 capacitors were within manufacturer's specifications

Storage Guidance from United Chemi Con

- After 1 year at 40C
 - Capacitance drops by 2%
 - Leakage current increases by approximately 2X
 - Tan delta stays the same
- After 2 years at 40C
 - Capacitance drops by 5%
 - Leakage current increases by approximately 5X
 - Tan delta stays the same

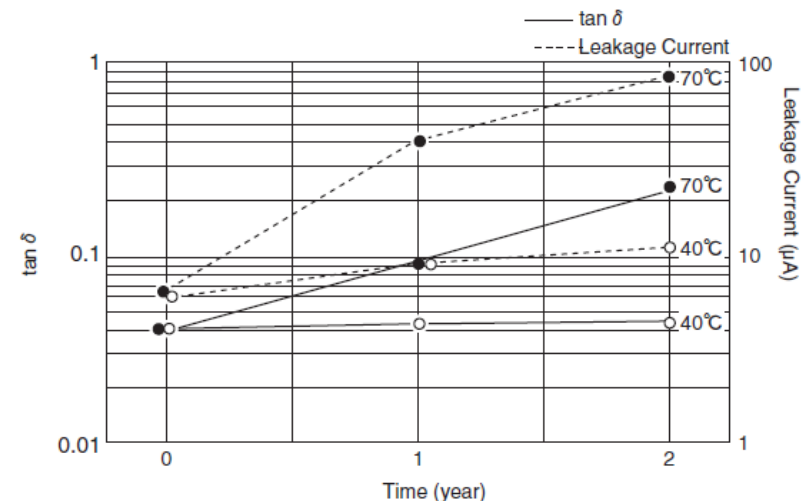
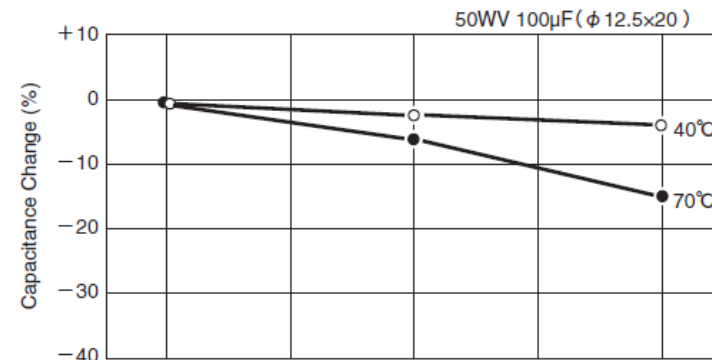
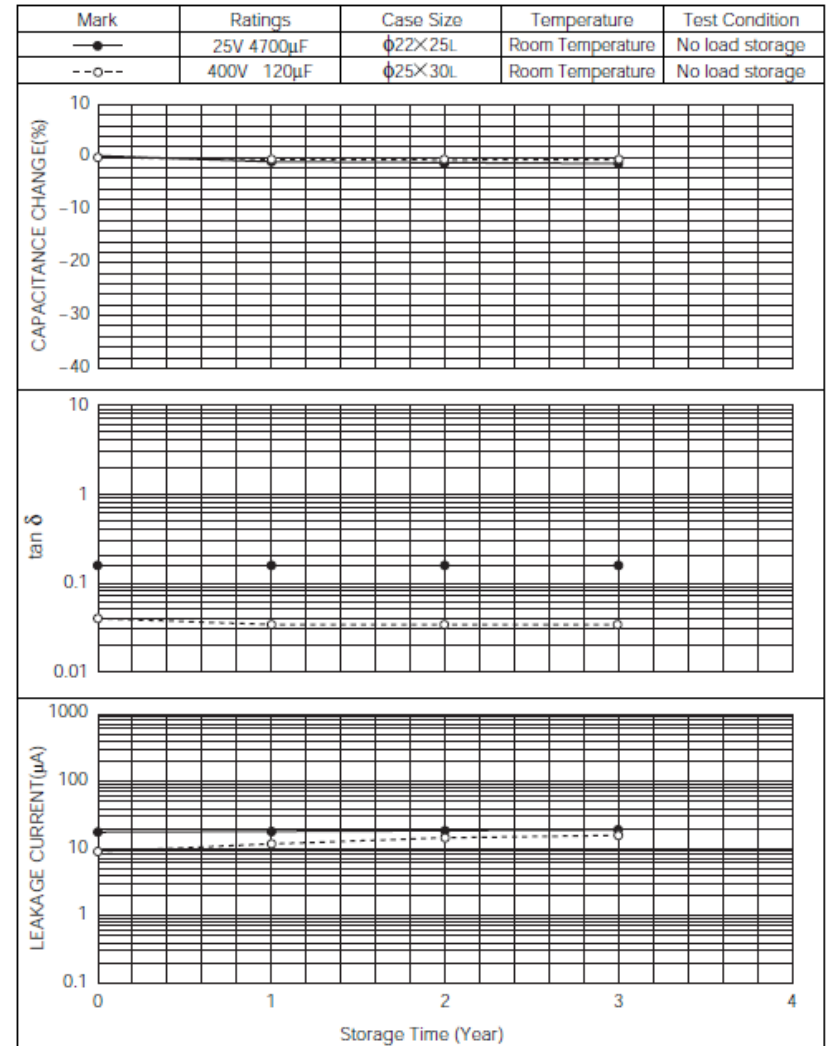

Fig-30 Temperature Characteristics of Storage

Storage Guidance from Nichicon

- Recommends no more than 2 years at 35C before forming is required
 - However, its data claims no degradation after 3 years
- Recommends recondition at rated voltage with 1k Ω resistor in series for 30 minutes



Storage Guidance from Rubycon

- Provides no guidance, but shows degradation results from shelf life test at 85C
- For 50V/10 μ F/5x11 capacitor
 - 30% reduction in capacitance after 7000 hours
 - Stable leakage current after initial 1000 hours

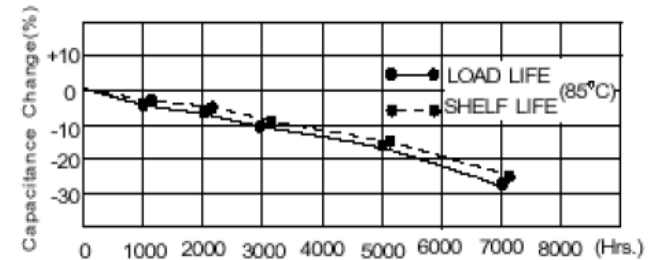

Fig. 3.10

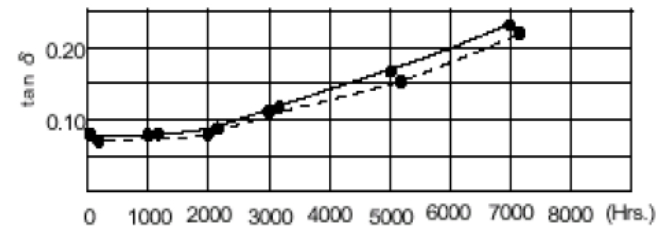

Fig. 3.11

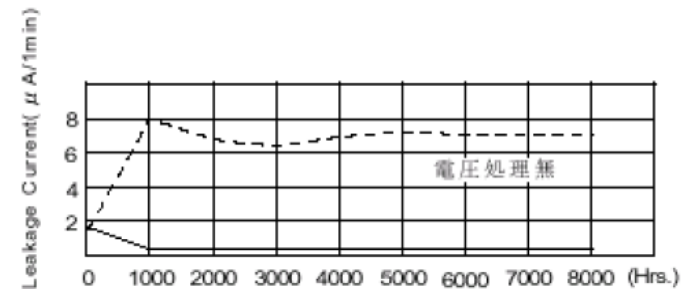

Fig. 3.12

Storage Guidance from Hitachi

- No more than 3 years at 35C

Storage Guidance from TDK/EPCOS

- 1000 hours at maximum rated temperature
- At least two years at 35C
 - Some model numbers can be stored up to 15 years (SIKOREL)

Storage Guidance from Cornell Dublier

- The following time limits apply to shelf life at 35°C 60%RH for all styles of CDE Aluminum Electrolytic capacitors
 - After 3 years, recommend testing before use to determine if reforming is required to meet leakage specifications
 - After 4 years, reforming is usually required before use
 - After 5 years, reforming is almost always necessary
 - After 10 years, near or at end of useful shelf life
- Recommend reforming procedure
 - Performed at room temperature with either a 10K ohms (for 75VDC) or 100K ohms (above 75VDC) resistor in series
 - After reaching rated voltage, continue to apply rated voltage for a minimum of 4 hours.

Storage Guidance from Kemet

- Formerly RIFA
- These are higher voltage, higher capacitance capacitors
 - More for industrial power applications
 - Electrolyte tends to be solvent based, which is more resistance to dielectric dissolution
 - States 10 years at 40C without the need for reconditioning

Storage Guidance from Panasonic

- After 12 months (temperature not defined), recondition at rated voltage with 1 k Ω resistor in series for 30 minutes

Conclusion

- Review of published literature indicates that there currently is a knowledge gap in regards to shelf life of aluminum electrolytic capacitors
 - Primarily in regards to dielectric dissolution
- As a general rule of thumb, literature suggests that modern electrolytic capacitors should be able to have a shelf life of three (3) years without the need for reformation
 - Dielectric dissolution can almost always be reversed through reformation

Conclusion (cont.)

- The questions not currently answered
 - What is the effect of temperature on dielectric dissolution?
 - For assembled capacitors, how to determine if the circuit would be sufficient to successfully reform the capacitor?
 - For assembled capacitors, what is the maximum leakage current before the system could be damaged during power up?

Disclaimer & Confidentiality

- **ANALYSIS INFORMATION**

This report may include results obtained through analysis performed by DfR Solutions' Sherlock software. This comprehensive tool is capable of identifying design flaws and predicting product performance. For more information, please contact sales@dfrsolutions.com.

- **DISCLAIMER**

DfR represents that a reasonable effort has been made to ensure the accuracy and reliability of the information within this report. However, DfR Solutions makes no warranty, both express and implied, concerning the content of this report, including, but not limited to the existence of any latent or patent defects, merchantability, and/or fitness for a particular use. DfR will not be liable for loss of use, revenue, profit, or any special, incidental, or consequential damages arising out of, connected with, or resulting from, the information presented within this report.

- **CONFIDENTIALITY**

The information contained in this document is considered to be proprietary to DfR Solutions and the appropriate recipient. Dissemination of this information, in whole or in part, without the prior written authorization of DfR Solutions, is strictly prohibited.

From all of us at DfR Solutions, we would like to thank you for choosing us as your partner in quality and reliability assurance. We encourage you to visit our website for information on a wide variety of topics. To help us continually improve, please send any feedback or comments to iso@dfrsolutions.com.

*Best Regards,
Dr. Craig Hillman, CEO*

